

Nuance[®] Dragon[®] Bluetooth Wireless Headset II

User Guide

For the Nuance[®] Dragon[®] family of speech recognition solutions

Anleitung in Deutsch: [Klicken Sie hier](#)

Guide en français : [cliquez ici](#)

Guía en español: [hacer clic aquí](#)

Copyright

Dragon Bluetooth Wireless Headset II

This material may not include some last-minute technical changes and/or revisions to the software. Changes are periodically made to the information provided here. Future versions of this material will incorporate these changes.

Nuance Communications, Inc. has patents or pending patent applications covering the subject matter contained in this document. The furnishing of this document does not give you any license to such patents.

No part of this manual or software may be reproduced in any form or by any means, including, without limitation, electronic or mechanical, such as photocopying or recording, or by any information storage and retrieval systems, without the express written consent of Nuance Communications, Inc. Specifications are subject to change without notice.

© Nuance Communications Inc. 2023

Nuance, the Nuance logo, the Dragon logo, Dragon, and RealSpeak are registered trademarks or trademarks of Nuance Communications, Inc. in the United States or other countries. All other names and trademarks referenced herein are trademarks of Nuance Communications or their respective owners. Designations used by third-party manufacturers and sellers to distinguish their products may be claimed as trademarks by those third-parties.

Disclaimer

Nuance makes no warranty, express or implied, with respect to the quality, reliability, currentness, accuracy, or freedom from error of this document or the product or products referred to herein and specifically disclaims any implied warranties, including, without limitation, any implied warranty of merchantability, fitness for any particular purpose, or noninfringement.

Nuance disclaims all liability for any direct, indirect, incidental, consequential, special, or exemplary damages resulting from the use of the information in this document. Mention of any product not manufactured by Nuance does not constitute an endorsement by Nuance of that product.

Notice

Nuance Communications, Inc. is strongly committed to creating high quality voice and data management products that, when used in conjunction with your own company's security policies and practices, deliver an efficient and secure means of managing confidential information.

Nuance believes that data security is best maintained by limiting access to various types of information to authorized users only. Although no software product can completely guarantee against security failure, Nuance Management Center software contains configurable password features that, when used properly, provide a high degree of protection.

We strongly urge current owners of Nuance products that include optional system password features to verify that these features are enabled. You can call our support line if you need assistance in setting up passwords correctly or in verifying your existing security settings.

Published by Nuance Communications, Inc., Burlington, Massachusetts, USA

Visit Nuance Communications, Inc. on the Web at www.nuance.com.

2/27/2023

Contents

About this guide	1
Guide overview	2
Audience	2
Chapter 1: Introduction	3
About the headset	4
Headset components	4
Technical specifications	6
Product safety	8
Chapter 2: Getting started	9
Charge your headset	10
Check your battery level	11
Turn your headset on and off	12
LED indicator lights	12
Audio alerts	12
Status icons	12
Pair your headset	14
Before you begin	14
Apple devices—iOS	14
Android devices—Android OS	15
Windows devices	16
Pair your headset with additional devices	18
Switch between paired devices	18
Wear your headset	19
Chapter 3: Dictating with your headset	20
Dictate — Dragon Professional solutions	21
Dictate — Dragon Anywhere	23
Dictate — Dragon Professional Anywhere	24
Chapter 4: Calling with your headset	25
Call basics	26
Make a call	26
Answer a call	26
End a call	26

Adjust the volume	26
Mute a call	26
Chapter 5: Using a voice assistant with your headset	27
Invoke your voice assistant	28
Appendix A: Troubleshooting and Maintenance	29
Troubleshoot your headset	30
Maintain your headset	33
Clean your headset	33
Support	34

About this guide

Guide overview	2
Audience	2

Guide overview

This guide contains the following:

- Technical specifications, system requirements, regular use instructions, troubleshooting procedures, and maintenance instructions for the Dragon Bluetooth Wireless Headset II

Audience

This guide is intended for Dragon users who will dictate with the headset on computers, tablets, and mobile phones.

This guide assumes you have a basic understanding of how to use those devices.

Chapter 1: Introduction

About the headset	4
Headset components	4
Technical specifications	6
Product safety	8

About the headset

Your Dragon Bluetooth wireless headset is designed for hands-free dictation using the Dragon family of speech recognition solutions. You can also use your headset to make and receive calls and to invoke the voice assistant for your device, such as Siri (iOS). You can dictate with Dragon when it's installed on your Bluetooth-capable computer, mobile phone, or tablet.





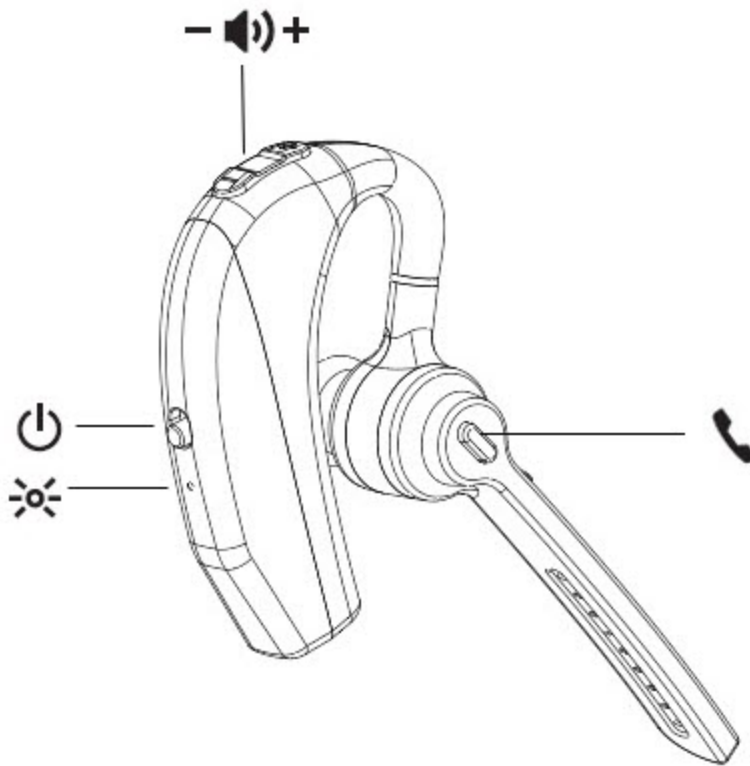

Your headset is supported on the following devices:

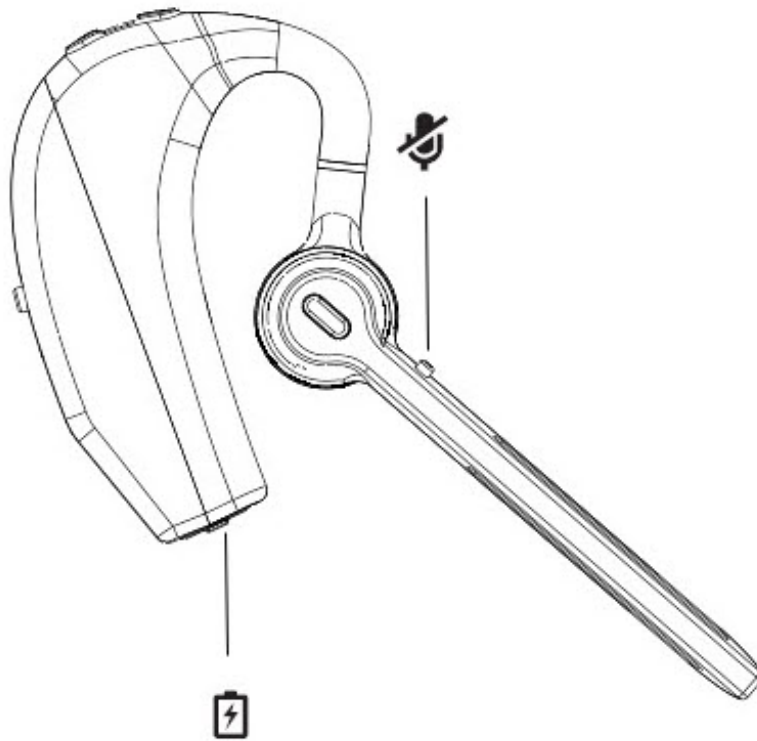
Operating System	Device Type	System Requirements
Apple iOS (phones, tablets)	<ul style="list-style-type: none"> • Phones • Tablets 	<ul style="list-style-type: none"> • Bluetooth
Android (phones, tablets)	<ul style="list-style-type: none"> • Phones • Tablets 	<ul style="list-style-type: none"> • Bluetooth
Windows (laptops, desktops, tablets)	<ul style="list-style-type: none"> • Laptops • Desktops • Tablets 	<ul style="list-style-type: none"> • Windows 7 or higher • Bluetooth

Headset components





Icon	Description
	Indicator light
	Power ON/OFF switch
	Volume Down (-) and Volume Up (+) buttons
	Call button
	Mute button
	Charge port

Technical specifications

Connectivity	Connection Type	Wireless
	Wireless Connectivity	Bluetooth
	Bluetooth Version	v5.0 + ERD/BLE
	Bluetooth Profiles	HSP1.2/HFP1.7.1/A2DP1.3.1/AVRCP1.6/SPP1.2/DI1.3/AVCTP1.4
	Maximum Wireless Range	10 meters/32.8 feet
	Frequency Range	2.400~2.480 GHz
General	Maximum Talk Time	8 hours
	Maximum Stand-By Time	240 hours
	Noise Cancellation Type	Clear Voice Capture (CVC) technology
	Headset Fit	In-Ear
	Headset Weight	22g
	Operating and storage temperature	32°F – 104°F (0 – 40°C)
	Water-resistant	Yes
	Sweat-resistant	Yes
	IP rating	IPX4
	Additional Accessories Included	USB-C charging cable
Power	Rechargeable	Yes
	Battery Type	Lithium Polymer 150mA
	Power Output	3mW (Rated)
	Charging Interface	USB-C

	Charging Time	Approximately 2 hours
	Charging Operating Voltage	DC 5V
	Operation Voltage	3.3-4.2V
	Operation Current	4-8mA

Product safety

This device complies with Part 15 of the FCC Rules. Operation is subject to the following two conditions: (1) this device may not cause harmful interference, and (2) this device must accept any interference received, including interference that may cause undesired operation.

Changes or modifications not expressly approved by the party responsible for compliance could void the user's authority to operate the equipment.

Bluetooth is a registered trademark of Bluetooth SIG, Inc. Other products and company names mentioned herein may be trademarks or trade names of their respective owners.

Chapter 2: Getting started

Charge your headset	10
Check your battery level	11
Turn your headset on and off	12
LED indicator lights	12
Audio alerts	12
Status icons	12
Pair your headset	14
Before you begin	14
Apple devices—iOS	14
Android devices—Android OS	15
Windows devices	16
Pair your headset with additional devices	18
Switch between paired devices	18
Wear your headset	19

Charge your headset

Your new headset comes partially charged and is ready for use directly out of the box. However, for maximum usage, Nuance recommends that you fully charge the headset for two hours before initial use.

Your headset comes with a charging cord. Do one of the following to charge your headset:

- Charge your headset with an adapter:
 1. Plug the USB-C end of the cord into your headset.
 2. Plug the USB end of the cord into an adapter (not included) and then plug the adapter into a power outlet.
- Charge your headset with your computer:
 1. Plug the USB-C end of the cord into your headset.
 2. Plug the USB end of the cord into an available USB port on your laptop or desktop computer.

Check your battery level

Your headset comes with a rechargeable battery that provides the following:

- 8 hours of talk time
- 240 hours of standby time

Use the USB-C charging cord included in the box to recharge it.

In general, the red LED indicator flashes continuously when the headset battery level is low. The following table describes additional battery life indicators for specific devices.

Device	Visual Indicator	Audio Indicator
Apple	The battery icon () in your device's status bar indicates the headset's remaining battery life.	<ul style="list-style-type: none"> • "Battery level is high"—100%-70% remaining • "Battery level is medium"—70%-30% remaining
Android	Battery life is indicated in 20% intervals in the Bluetooth menu.	<ul style="list-style-type: none"> • "Battery level is low"—less than 30% remaining

Turn your headset on and off

Power on	Slide the ON/OFF switch upward, away from the red LED indicator. You'll hear audio prompt "Power On". Note: Turning your headset on does not turn on Dragon's microphone. To turn on Dragon's microphone, see the appropriate section for turning on Dragon's microphone in "Dictating with your headset" on page 20 .
Power off	Slide the ON/OFF switch downward, towards the red LED indicator. You'll hear audio prompt "Disconnected". Note: Turning your headset off does not turn off Dragon's microphone.

LED indicator lights

LED light	Indicator
Red and blue LED flashing alternately	Headset is in pairing mode.
One long blue LED flash followed by one short blue and red LED flash	Headset is turned on and paired with your device.
Red LED flashing	Low battery.





Audio alerts

You'll hear the following audio alerts when you power on your headset:

Alert	Description
"Power On"	Headset is powered on.
"Connected"	Headset is connected to a paired device.
"Disconnected"	Headset is no longer connected to a paired device.
"Battery level is high" "Battery level is medium" "Battery level is low"	Battery life indicator.

Status icons

The following icons appear in your device's status bar when using your Dragon Bluetooth Headset II.

Icon	Operating System	Description
	Apple	Headset is paired with your Apple device.
	Apple	Remaining headset battery life.
	Android	Headset is paired with your Android device.
	Windows	Headset is paired with your Windows device.

Pair your headset

Your Dragon Bluetooth Headset II is in pairing mode by default when you first turn it on. The red and blue LED indicators flash alternately to indicate the headset is in pairing mode. To enable pairing mode manually, see [“Pair your headset with additional devices” on page 18](#).

Your headset can be paired with a maximum of one device at a time.

Before you begin

For best results, do the following before attempting to pair your headset with any devices:

1. Disable the **Bluetooth** setting on all devices you want to pair with your headset.
 - **Apple devices**
 1. Turn on your Apple device.
 2. Tap **Settings>Bluetooth**.
 3. Disable the **Bluetooth** setting.
 - **Android devices**
 1. Turn on your Android device.
 2. Access your Quick Settings menu by swiping down from the top of your screen.
 3. Tap the Bluetooth icon () to disable Bluetooth.
 - **Windows devices**
 1. Turn on your Windows desktop or laptop.
 2. Launch **Settings>Devices>Bluetooth and other devices**.
 3. Disable the **Bluetooth** setting.
2. Turn off all Bluetooth devices that connect to the device you are attempting to pair with your headset.
3. Perform a hard reset on your headset. This is strongly recommended by the manufacturer to ensure successful pairing.
 1. Turn on your headset.

The red and blue LED indicators flash alternately.
 2. Hold down the **Call+Mute** buttons simultaneously for 3 seconds, and then release.

Note: No visual indicator occurs when the reset is complete.

Apple devices—iOS

1. Turn on your Apple device.
2. Tap **Settings>Bluetooth**.
3. Enable Bluetooth.
4. Turn on your Dragon Bluetooth Headset II.

The red and blue LED lights flash to indicate the headset is in pairing mode.

Your headset appears in the list of devices on the **Settings>Bluetooth** page.

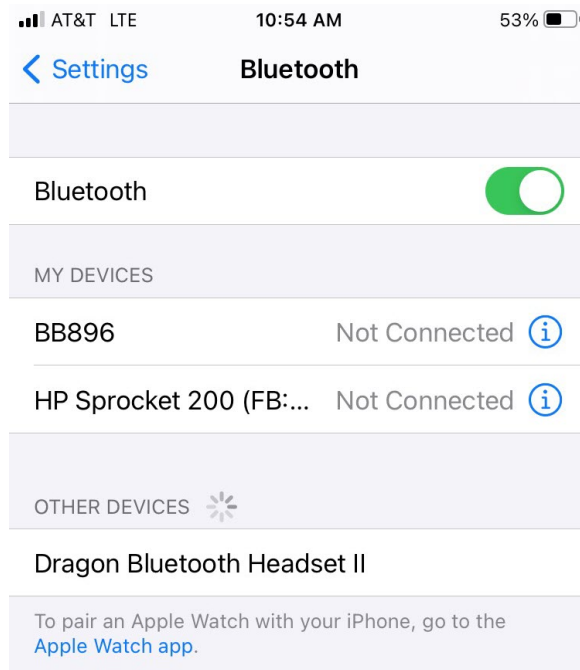

If your headset doesn't appear in the list, see [“Troubleshoot your headset” on page 30](#).

5. Tap **Dragon Bluetooth Headset II**.

When paired successfully, the red and blue LED lights stop flashing, and the following icons appear in your device's status bar:



Use the battery icon to determine your headset's remaining battery life.

Note: Your headset remains paired with your device automatically unless you manually disconnect or unpair it.

Android devices—Android OS

1. Turn on your Android device.
2. Access your Quick Settings menu by swiping down from the top of your screen.

3. Tap the Bluetooth icon () to enable Bluetooth.
4. Touch and hold the Bluetooth icon.
5. Tap **Pair new device** or look under **Available devices**.

If your headset doesn't appear in the list, see [“Troubleshoot your headset” on page 30](#).

6. Tap **Dragon Bluetooth Headset II**.

When paired successfully, the red and blue LED lights stop flashing.

Note: Your headset remains paired with your device automatically unless you manually unpair it.

Windows devices

1. Turn on your Dragon Bluetooth Headset II.
2. Turn on your Windows desktop or laptop.
3. Launch **Settings>Devices>Bluetooth and other devices**.
4. Enable the **Bluetooth** setting.
5. Click **Add Bluetooth or other device**.

The Add a device dialog box opens.

6. Click **Bluetooth**.

Your Windows device searches for discoverable Bluetooth devices.

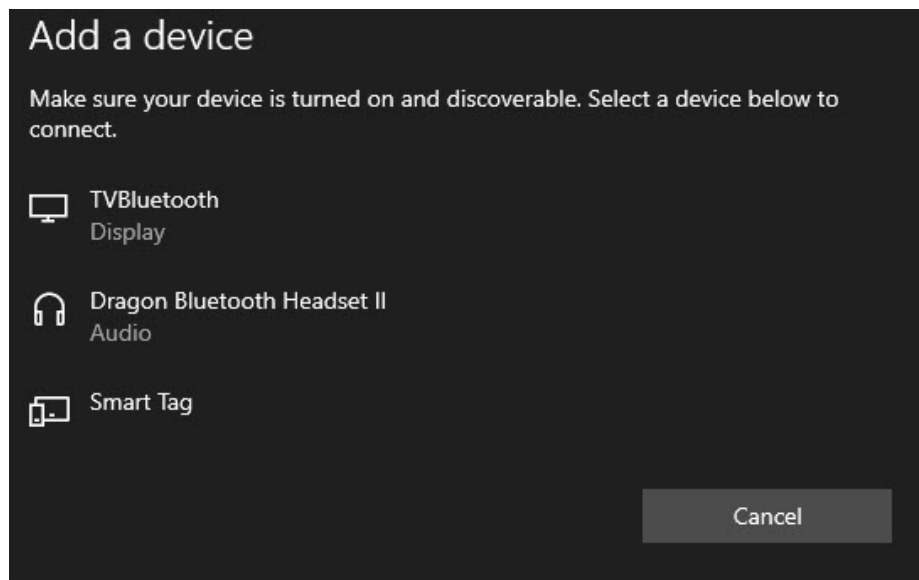

If your headset doesn't appear in the list, see [“Troubleshoot your headset” on page 30](#).

7. Select **Dragon Bluetooth Headset II**.

Windows sets up your headset. When the setup is complete, a confirmation dialog box appears.

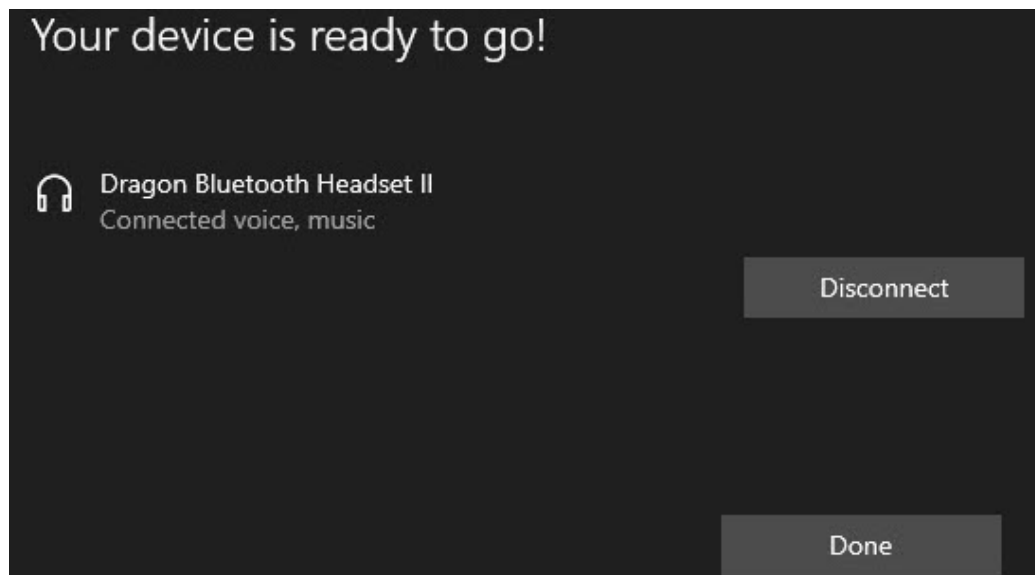

8. Click **Done**.

Your headset now appears on the Bluetooth & other devices page.

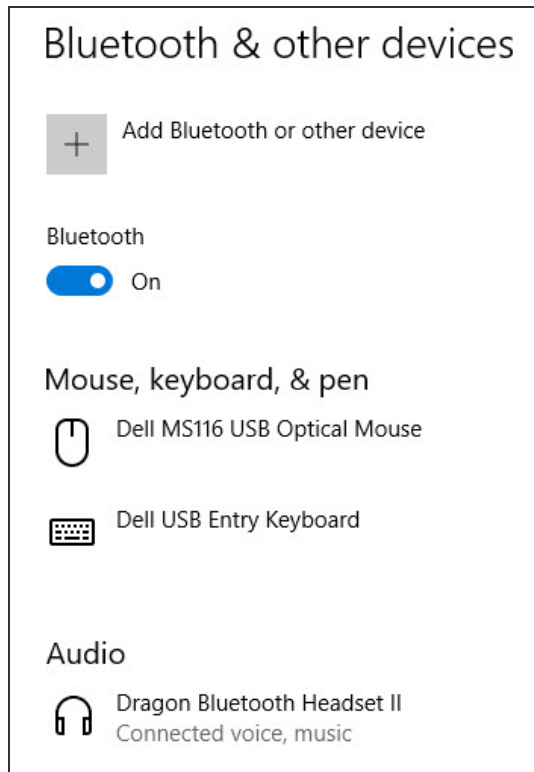

Note: Your headset remains paired with your device automatically unless you manually disconnect or unpair it.



Pair your headset with additional devices

Your headset can be paired with a maximum of one device at a time.

1. Turn on your device and ensure Bluetooth is enabled.
2. Press and hold the **Call** button on the headset until the red and blue lights are flashing to put it in pairing mode.
3. Follow the appropriate instructions for your device in [“Pair your headset” on page 14](#).

Switch between paired devices

To switch between paired devices, manually disconnect from one paired device and then connect to another.

1. On the paired device to which your headset is currently connected, open the Bluetooth menu:
 - **Apple devices**—Tap **Settings>Bluetooth**.
 - **Android devices**—Access the Quick Settings menu and tap the Bluetooth icon ().
 - **Windows devices**—Launch **Settings>Devices>Bluetooth and other devices**.
2. Disconnect your headset:
 - **Apple devices**—In the My Devices list, tap the Info icon () next to **Dragon Bluetooth Headset II**, and then tap **Disconnect**.
 - **Android devices**—In the Available Devices list, tap **Disconnect** next to **Dragon Bluetooth Headset II**.
 - **Windows devices**—On the **Settings>Devices>Bluetooth and other devices** page, click **Dragon Bluetooth Headset II**, and then click the **Disconnect** button.

You'll hear audio prompt "Disconnected".

The red and blue LED lights flash to indicate the headset is in pairing mode.

3. On the second device, open the Bluetooth menu.

See step 1 for specific instructions.
4. Connect your headset:
 - **Apple devices**—In the My Devices list, tap **Dragon Bluetooth Headset II**.
 - **Android devices**—In the Available Devices list, tap **Dragon Bluetooth Headset II**.
 - **Windows devices**—On the **Settings>Devices>Bluetooth and other devices** page, click **Dragon Bluetooth Headset II**, and then click the **Connect** button.

You'll hear audio prompt "Connected".

The red and blue LED lights stop flashing.

Wear your headset

The headset is designed to be worn on either ear.

Adjust	<ol style="list-style-type: none">1. Flip the microphone boom towards you, then rotate the ear piece away from you.2. Lower the microphone boom.
Wear	<ol style="list-style-type: none">1. Slide the headset over your ear, then press the earpiece gently inward toward your ear. Tip: For best fit, first remove your eyeglasses if you wear them.2. Position the microphone towards your mouth for optimal recognition accuracy.

Chapter 3: Dictating with your headset

Dictate — Dragon Professional solutions	21
Dictate — Dragon Anywhere	23
Dictate — Dragon Professional Anywhere	24

Dictate — Dragon Professional solutions

Use these instructions to dictate with the following Dragon products:

- Dragon Professional Individual
- Dragon Professional Group
- Dragon Legal Individual
- Dragon Legal Group
- Dragon Law Enforcement
- Dragon Home

To dictate with Dragon Professional and Dragon Home:

1. Turn your headset on.
You'll hear audio prompt "Connected".
2. Open Dragon.
3. If you don't already have a user profile, Dragon prompts you to create one.
You can choose your headset as your microphone after you create your user profile.
4. If you already have a user profile, from the **Settings** menu, select **Microphone>Choose Microphone**.

The Choose a Microphone dialog box appears.

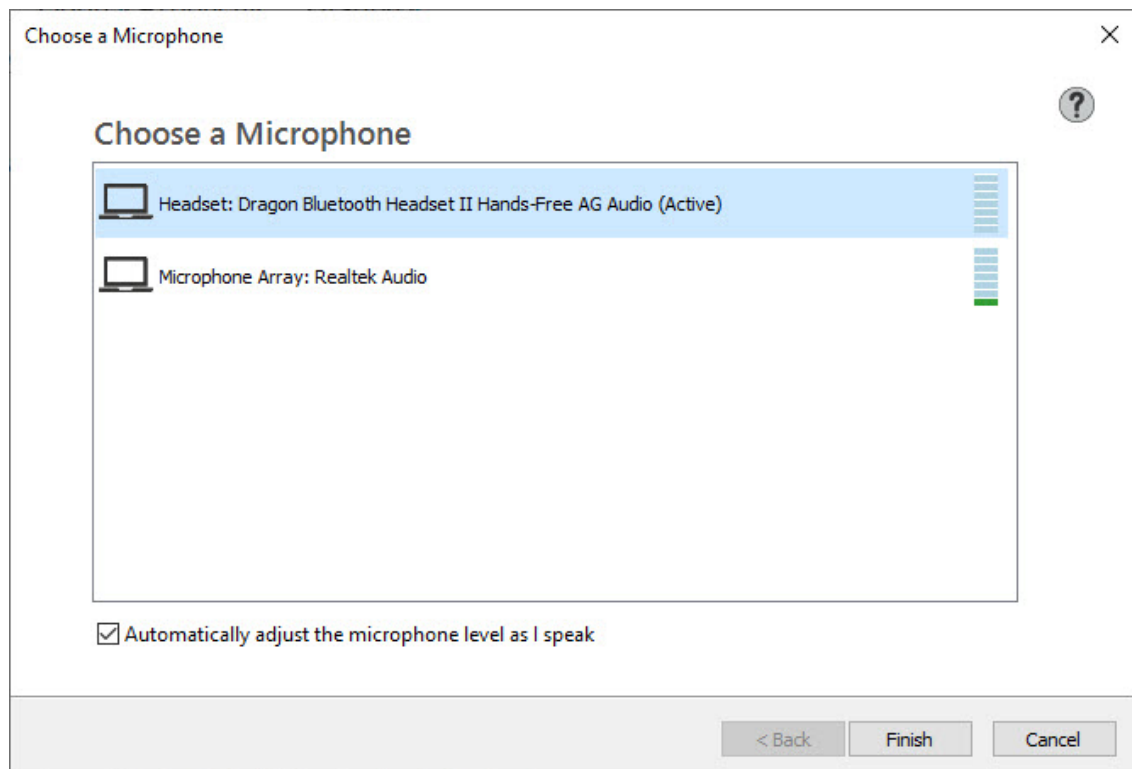

5. Select **Headset: Dragon Bluetooth Headset II** and then click **Next**.

Dragon sets up your microphone.

6. Click **Finish**.



7. From the DragonBar, click the microphone button () and begin dictating when the button turns green.

Note: Turning off Dragon's microphone does not turn off your headset. To conserve battery life when you're not dictating, turn your headset off.

Dictate — Dragon Anywhere

1. Turn your headset on.

You'll hear audio prompt "Connected".

2. Open Dragon Anywhere.



3. Tap Dragon's microphone button () and begin dictating when the button turns green.

Dragon uses the Bluetooth headset for dictation automatically. If you unpair or shut off the Bluetooth headset, Dragon uses the microphone on your iOS or Android device.

Dictate — Dragon Professional Anywhere

Use these instructions to dictate with the following Dragon products:

- Dragon Professional Anywhere
- Dragon Legal Anywhere

1. Turn your headset on.

You'll hear audio prompt "Connected".

2. Open Dragon Professional Anywhere.

3. From the DragonBar, select **Microphone>Headset (Dragon Bluetooth Headset II Hands-Free AG Audio)**.

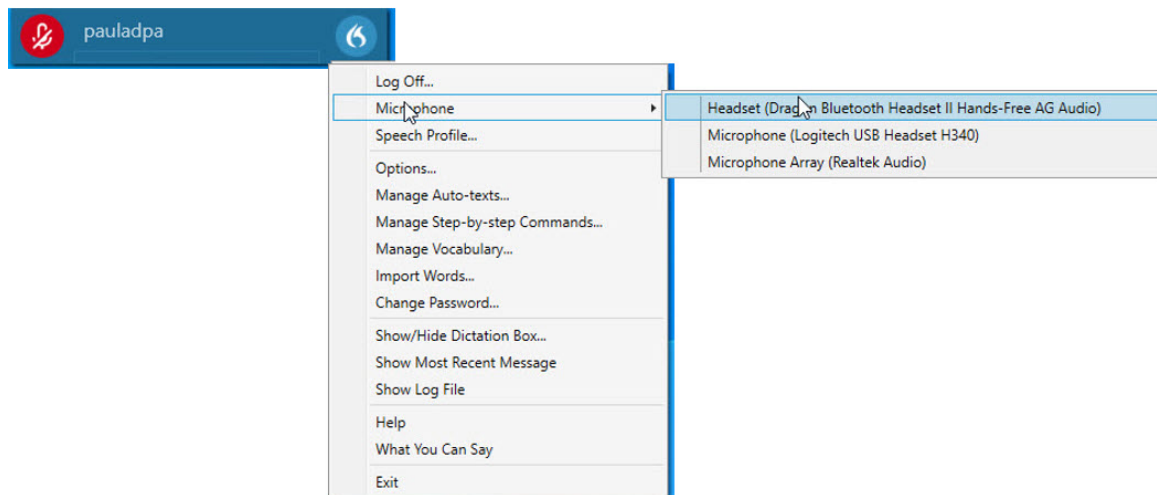

4. Tap Dragon's microphone button () and begin dictating when the button turns green.

Chapter 4: Calling with your headset

Call basics	26
Make a call	26
Answer a call	26
End a call	26
Adjust the volume	26
Mute a call	26

Call basics

Make a call

1. Ensure your Dragon Bluetooth Headset II is on and connected to your phone.
2. Make a call on your phone.
You'll hear the audio through your headset.
3. Adjust the volume using the Volume Down (-) and Volume Up (+) buttons.
4. Press the **Call** button () to end the call.

Answer a call

Press the Call button () when you are receiving an incoming call.

End a call

Press the Call button ().

Adjust the volume

Press the **Volume up** button (+) or **Volume down** button (-).

Mute a call

Press the Mute button ().

Chapter 5: Using a voice assistant with your headset

Invoke your voice assistant	28
--	-----------

Invoke your voice assistant

You can invoke the following voice assistants with your headset:

- Siri (iOS)
- Google Assistant™ (Android OS)
- Cortana (Windows)

Before invoking your voice assistant, first check the settings on your device to determine whether the assistant requires a wake up word (such as "Hey Siri") to open it.

To invoke your voice assistant:



1. Double-tap the **Call** button () on your headset.
2. Do one of the following:
 - If your device requires a wake up word, say the word ("Hey Siri", "Hey Google", or "Hey Cortana") and then say a command or question.
 - If your device does not require a wake up word, say a command or question.

Appendix A: Troubleshooting and Maintenance

Troubleshoot your headset	30
Maintain your headset	33
Clean your headset	33
Support	34

Troubleshoot your headset

Issue	Procedures
Headset won't pair	<p>All device types (Apple, Android, Windows):</p> <ul style="list-style-type: none"> • Ensure you've performed the recommended steps before pairing: <ul style="list-style-type: none"> • Disable the Bluetooth setting on all devices you want to pair with your headset. <p>For instructions, see “Pair your headset” on page 14.</p> • Turn off all Bluetooth devices that connect to the device you are attempting to pair with your headset. <p>Your device might have difficulty discovering your Dragon Bluetooth headset if there are many other Bluetooth devices in range. If your headset isn't listed in the list of available devices and you can't turn off other Bluetooth devices in range, consider moving to a different area where there are fewer Bluetooth devices.</p> <ul style="list-style-type: none"> • Perform a hard reset on your headset. <p>For instructions, see “Pair your headset” on page 14.</p> <ul style="list-style-type: none"> • Restart the device you're attempting to pair with your headset. • Move your headset closer to your device. Your headset has a range of 10 meters/32.8 feet. <p>Apple and Android devices:</p> <ul style="list-style-type: none"> • If you selected Forget This Device on your Android or Apple device, do one of the following to allow your Dragon Bluetooth headset to re-appear in the list of devices when pairing: <ul style="list-style-type: none"> • Apple (iOS 15 or later)—Select Settings>General>Transfer or Reset [Device]>Reset>Reset Network Settings. • Android <ol style="list-style-type: none"> 1. Go to Settings>System and tap the Advanced drop-down

	<p>button.</p> <ol style="list-style-type: none"> 2. Select Reset options and then tap Reset Wi-Fi, mobile, & Bluetooth. 3. Tap the Reset settings button. <p>For more information, consult the technical documentation for your device.</p> <p>Windows devices:</p> <ul style="list-style-type: none"> • Check for and install any Windows updates. This downloads any necessary files that may be missing. • Run the Windows 10 Bluetooth troubleshooter. This can scan for and fix any Bluetooth problems. <p>From the Start menu, select Settings>Update & Security> Troubleshoot >Bluetooth.</p>
<p>Can't dictate</p>	<ul style="list-style-type: none"> • Ensure Dragon's microphone button is on. Turning on your headset does not turn on Dragon's microphone automatically. Click or tap Dragon's microphone button and begin dictating when it turns green. • Disconnect your headset and then reconnect it. Do the following: <ol style="list-style-type: none"> 1. Open the Bluetooth menu: <ul style="list-style-type: none"> • Apple devices—Tap Settings>Bluetooth. • Android devices—Access the Quick Settings menu and tap the Bluetooth icon (). • Windows devices—Launch Settings>Devices>Bluetooth and other devices. 2. Disconnect your headset: <ul style="list-style-type: none"> • Apple devices—In the My Devices list, tap the Info icon () next to Dragon Bluetooth Headset II, and then tap Disconnect. • Android devices—In the Available Devices list, tap Disconnect next to Dragon Bluetooth Headset II.

	<ul style="list-style-type: none"> • Windows devices—On the Settings>Devices>Bluetooth and other devices page, click Dragon Bluetooth Headset II, and then click the Disconnect button. <p>You'll hear audio prompt "Disconnected".</p> <p>The red and blue LED lights flash to indicate the headset is in pairing mode.</p> <p>3. Open the Bluetooth menu.</p> <ul style="list-style-type: none"> • Apple devices—Tap Settings>Bluetooth. • Android devices—Access the Quick Settings menu and tap the Bluetooth icon (). • Windows devices—Launch Settings>Devices>Bluetooth and other devices. <p>4. Re-connect your headset:</p> <ul style="list-style-type: none"> • Apple devices—In the My Devices list, tap Dragon Bluetooth Headset II. • Android devices—In the Available Devices list, tap Dragon Bluetooth Headset II. • Windows devices—On the Settings>Devices>Bluetooth and other devices page, click Dragon Bluetooth Headset II, and then click the Connect button. <p>You'll hear audio prompt "Connected".</p> <p>The red and blue LED lights stop flashing.</p>
<p>Audio recognition is poor</p>	<ul style="list-style-type: none"> • Ensure the headset is in close range of your device and there are no large objects between the headset and your device.

Maintain your headset

- Keep the headset dry and away from water.
- Do not expose the headset to direct sunlight or hot places. High temperatures will shorten the life of electronic devices, destroy the battery, or distort plastic components.
- Do not expose the headset to extreme cold.
- Do not attempt to dismantle the headset components.
- Do not drop the product on hard surfaces.
- Do not use harsh chemicals or detergent to clean the headset components.

Clean your headset

Use a dry microfiber cloth to wipe down your headset. This helps remove light buildup without scratching the device.

Support

Need more help? Contact Technical Support Monday-Friday at one of the following numbers:

- **US-based customers**

- 1-857-214-6311

- **International customers**

- +44 (0) 20 3027 4217 (UK)(9:00 AM - 5:00 PM GMT)
- +49 (0) 69 51709363 (Germany)(9:00 AM - 5:00 PM CET/CEST)
- +33 (0) 1 706 15495 (France)(9:00 AM - 5:00 PM CET/CEST)
- +31 (0) 20 346 9373 (Netherlands)(9:00 AM - 5:00 PM CET/CEST)
- +39 (0) 269633496 (Italy)(9:00 AM - 5:00 PM CET/CEST)
- +34 (0) 91275 4439 (Spain)(9:00 AM - 5:00 PM CET/CEST)
- +61 1300 856 388 (Australia)(9:00 AM - 5:00 PM AEST)
- +64 0800 523 585 (New Zealand)(9:00 AM - 5:00 PM NZST)
- 001 514 228 9199 (Canada)(9:00 AM - 5:00 PM EST)